

SAJAM PROIZVODNIH TEHNOLOGIJA

24-25. oktobar 2019 • Novosadski sajam

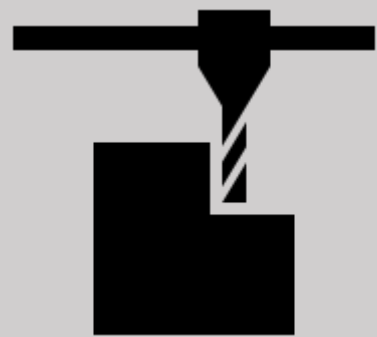

CNC
mašine

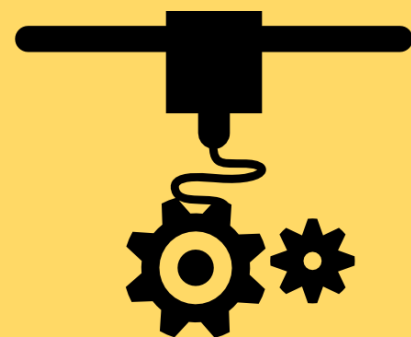

3D
štampa



3D
skeniranje

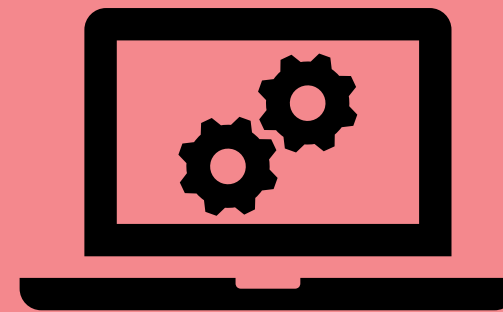

CAD CAM
softveri

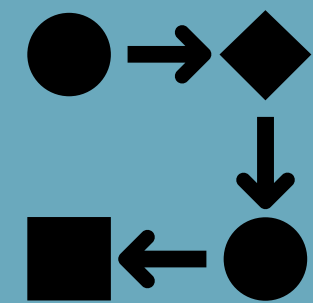

PDM PLM
rešenja

SOLFINS



STROJOTEHNIKA

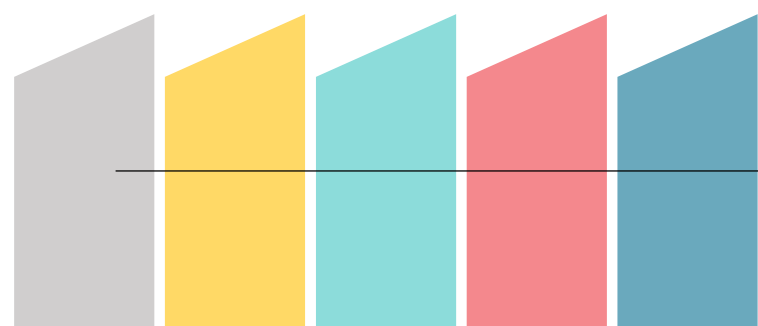

SAJAM PROIZVODNIH TEHNOLOGIJA

24-25. oktobar 2019 • Novosadski sajam

**POSLOVNI
SASTANCI**
konsultacije
saveti
preporuke
rešenja

organizatori:

SOLFINS

 **STROJOTEHNIKA**



pratite
demonstracije



tražite
savet



razmenite
ideje



testirajte
softvere



povežite
se



sklopite
poslove

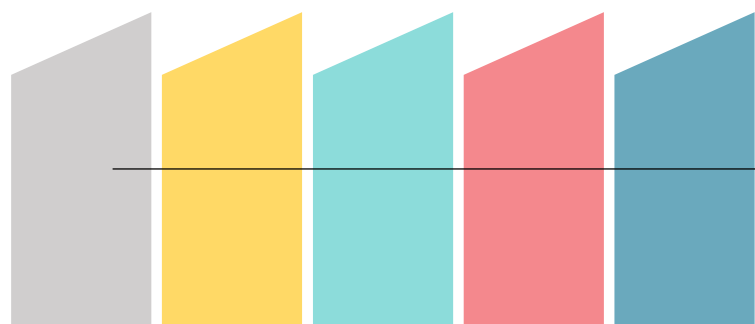

SAJAM PROIZVODNIH TEHNOLOGIJA

24-25. oktobar 2019 • Novosadski sajam

**POSLOVNI
SASTANCI**
konsultacije
saveti
preporuke
rešenja

organizatori:

SOLFINS

 **STROJOTEHNIKA**



slika: Sajam proizvodnih tehnologija 2018

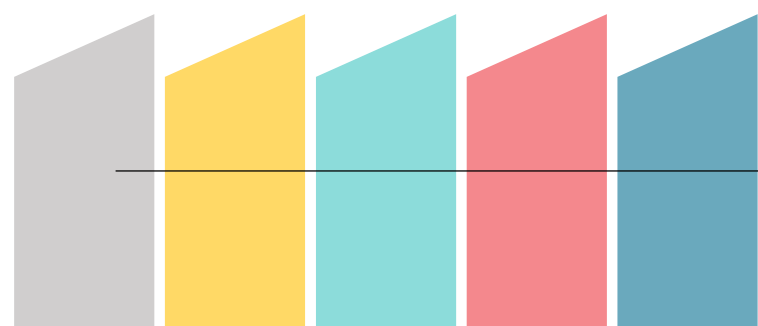

SAJAM PROIZVODNIH TEHNOLOGIJA

24-25. oktobar 2019 • Novosadski sajam

30+
VODEĆIH
BRENDOVA
INDUSTRIJE



organizatori:

SOLFINS

 **STROJOTEHNIKA**

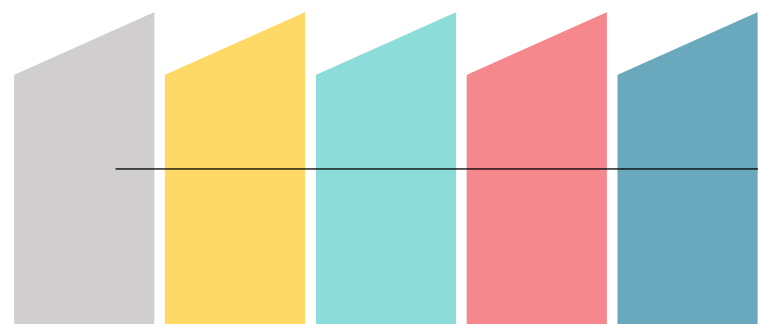

SAJAM PROIZVODNIH TEHNOLOGIJA

24-25. oktobar 2019 • Novosadski sajam

**OVO VAS
ČEKA NA
SAJMU!
I još mnogo
toga..**

organizatori:

SOLFINS

 **STROJOTEHNIKA**

CNC i mašinska obrada UŽIVO

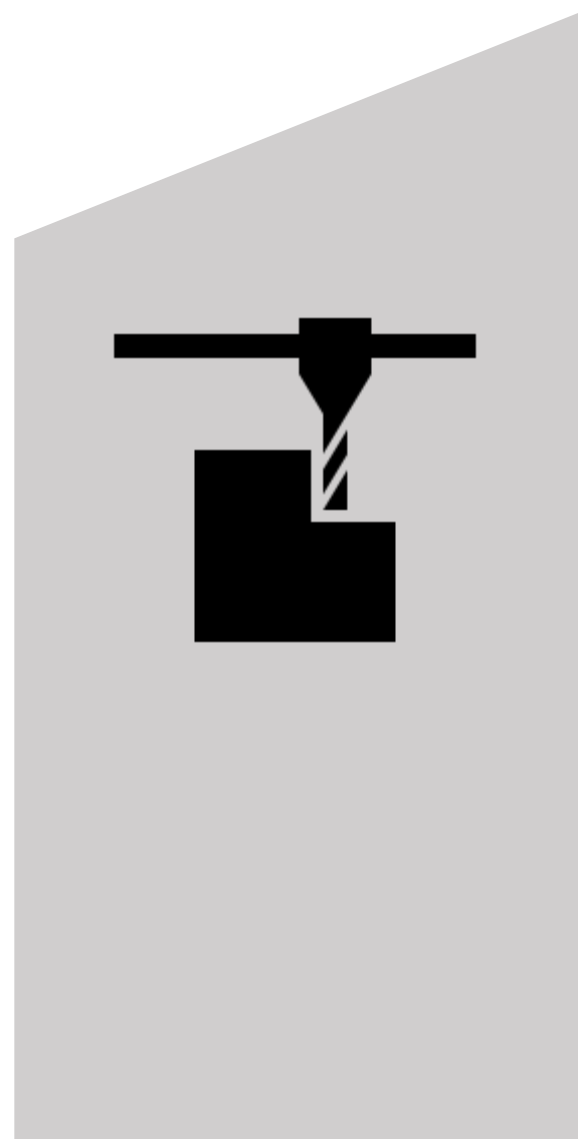

Izložene CNC mašine biće puštane u rad pomoću G-kodova koje ćemo generisati na licu mesta, uz praktične savete za povećanje efikasnosti. Na sajmu vas čeka i veliki izbor alata.

MILLER
PRÄZISIONSWERKZEUGE

HAIMER

TRIAG

SARTORIUS
Werkzeuge

BECK
Präzisionswerkzeuge

GRIMME

HELLER

INDEX

correa

TRAUB

INNOTOOL

ZK

HURCO

Okamoto

SolidCAM

DELmia

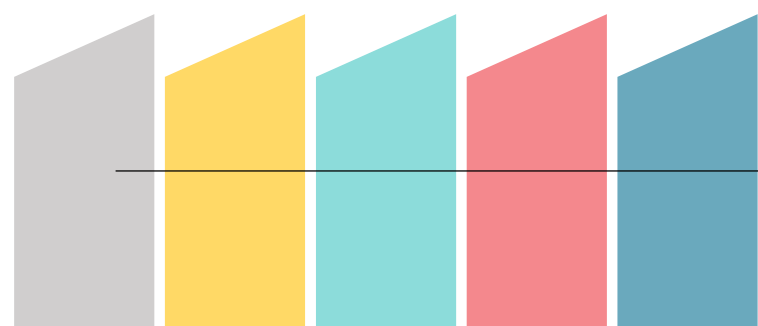

SAJAM PROIZVODNIH TEHNOLOGIJA

24-25. oktobar 2019 • Novosadski sajam

**OVO VAS
ČEKA NA
SAJMU!
I još mnogo
toga..**

organizatori:

SOLFINS

 **STROJOTEHNIKA**



TAKUMI H10
CNC mašina

prezentacija uživo
demonstracija rada
programiranje mašine i
obrada komada na
licu mesta

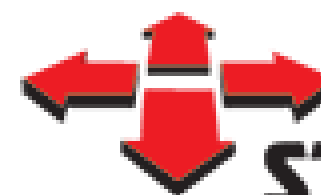

STROJOTEHNIKA

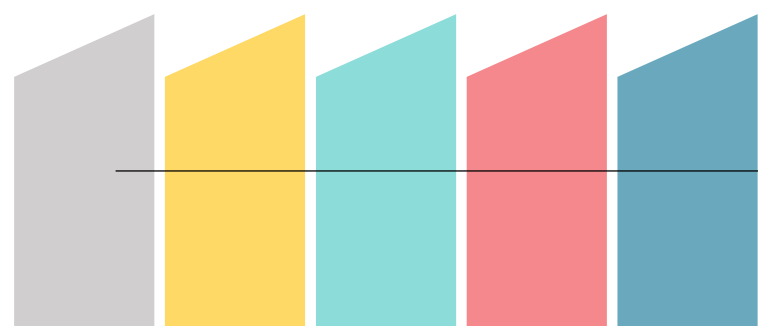

SAJAM PROIZVODNIH TEHNOLOGIJA

24-25. oktobar 2019 • Novosadski sajam

**OVO VAS
ČEKA NA
SAJMU!
I još mnogo
toga..**



Okamoto ACC 52 SA
NC planska brusilica

organizatori:

SOLFINS

 **STROJOTEHNIKA**

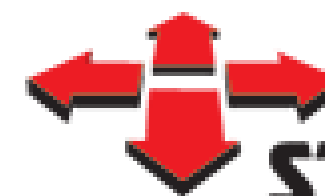

STROJOTEHNIKA

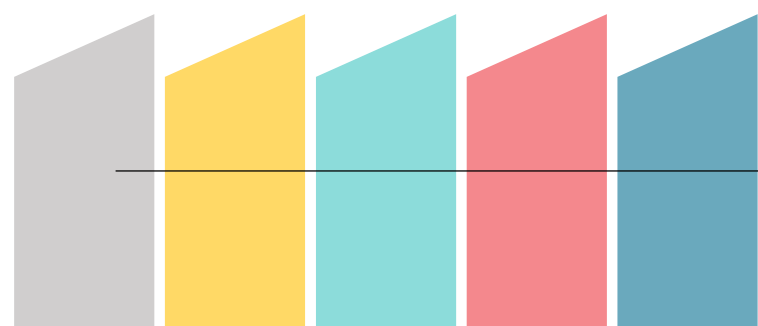

SAJAM PROIZVODNIH TEHNOLOGIJA

24-25. oktobar 2019 • Novosadski sajam

**OVO VAS
ČEKA NA
SAJMU!
I još mnogo
toga..**

organizatori:

SOLFINS

 **STROJOTEHNIKA**



Haimer VIO Linear
mašina za umeravanje
alata

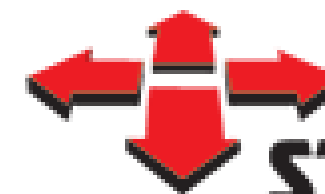

STROJOTEHNIKA

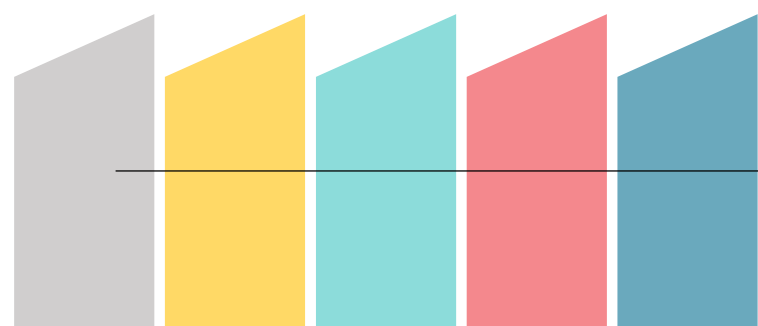

SAJAM PROIZVODNIH TEHNOLOGIJA

24-25. oktobar 2019 • Novosadski sajam

**OVO VAS
ČEKA NA
SAJMU!
I još mnogo
toga..**

organizatori:

SOLFINS

 **STROJOTEHNIKA**



Haimer Power clamp
comfort NG
mašina za termo grip
stezanje alata

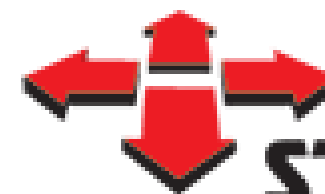

STROJOTEHNIKA

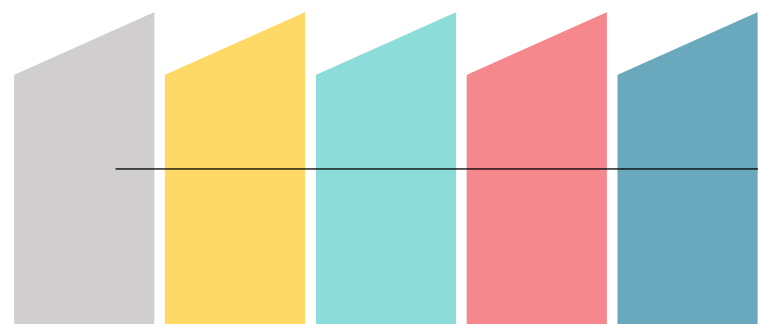

SAJAM PROIZVODNIH TEHNOLOGIJA

24-25. oktobar 2019 • Novosadski sajam

**OVO VAS
ČEKA NA
SAJMU!
I još mnogo
toga..**

organizatori:

SOLFINS

 **STROJOTEHNIKA**

3D štampači i štampa UŽIVO

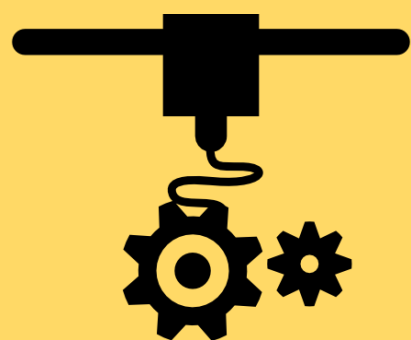

Saznajte kako da smanjite troškove izrade prototipova, alata, steznog pribora, mekih paknova, kontrolnika, ali i kako da proizvodite direktno na mašinama zasnovanim na aditivnim tehnologijama proizvodnje.

 **Markforged**

 **3D SYSTEMS**

formlabs 

Sindoh 

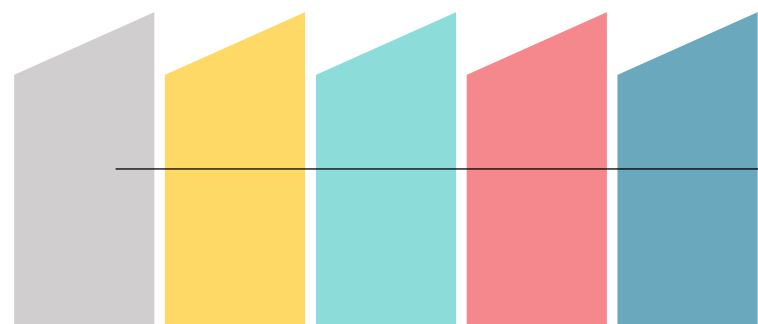

SAJAM PROIZVODNIH TEHNOLOGIJA

24-25. oktobar 2019 • Novosadski sajam

**3D ŠTAMPA
SKENIRANJE
demonstracije
delova,
tehnologija i
softvera**

organizatori:

SOLFINS

 **STROJOTEHNIKA**

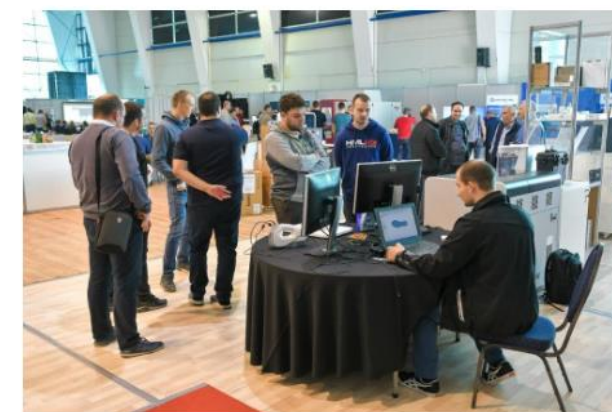

slike: Sajam proizvodnih tehnologija 2018



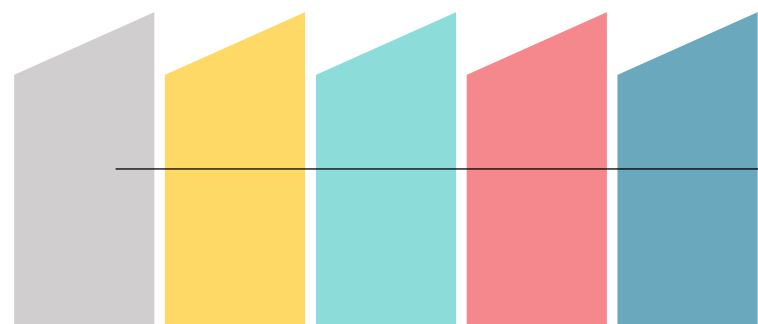

SAJAM PROIZVODNIH TEHNOLOGIJA

24-25. oktobar 2019 • Novosadski sajam

**OVO VAS
ČEKA NA
SAJMU!
I još mnogo
toga..**

organizatori:

SOLFINS

 **STROJOTEHNIKA**

3D skeneri i 3D skeniranje UŽIVO



Jednostavno digitalizujte i najsloženiju geometriju fizičkog modela, kreirajte nepostojeću dokumentaciju, i brzo napravite želje ismene kroz proces reverznog inženjeringa da napravite nove, kvalitetnije i konkurentnije proizvode za savremeno tržište.



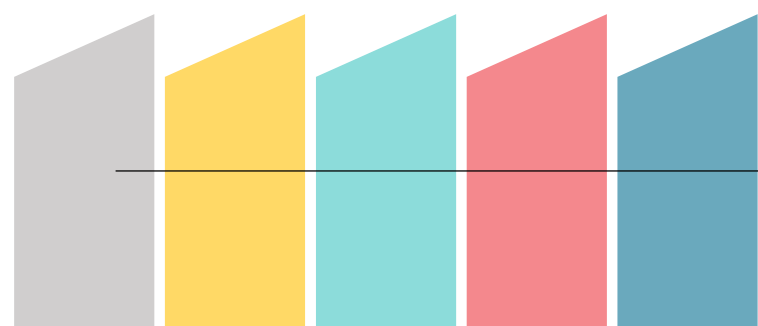

SAJAM PROIZVODNIH TEHNOLOGIJA

24-25. oktobar 2019 • Novosadski sajam

**OVO VAS
ČEKA NA
SAJMU!
I još mnogo
toga..**

organizatori:

SOLFINS

 **STROJOTEHNIKA**

Napredna softverska rešenja

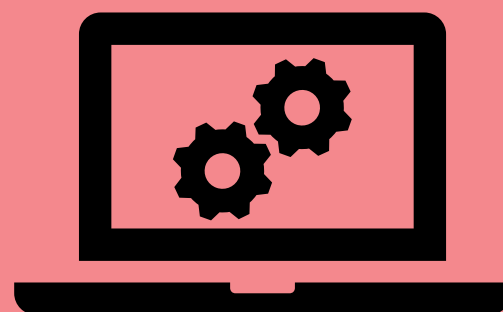

Savremeni softveri za 2D i 3D CAD projektovanje, elektroprojektovanje, PCB, FEA i CFD simulacije, upravljanje kontrolom kvaliteta, generisanje profesionalnih uputstava, upravljanje dokumentacijom i praćenje izmena, foto i video renderovanje...

 **SOLIDWORKS**

 **DASSAULT
SYSTEMES**

 **CATIA**

 **DELMIA**

 **SIMULIA**

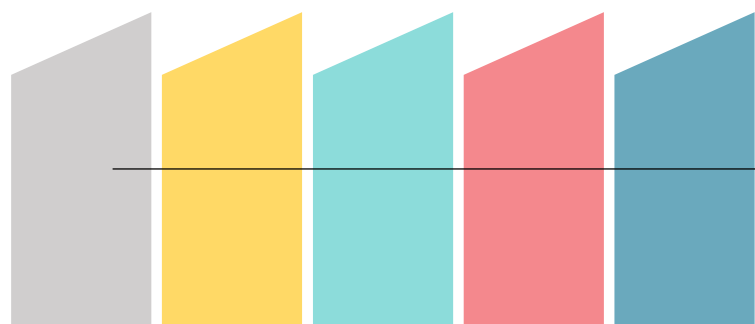

SAJAM PROIZVODNIH TEHNOLOGIJA

24-25. oktobar 2019 • Novosadski sajam

**OKRUGLI
STOLOVI
demonstracije
softverskih
rešenja**

organizatori:

SOLFINS

 **STROJOTEHNIKA**



slike: Sajam proizvodnih tehnologija 2018



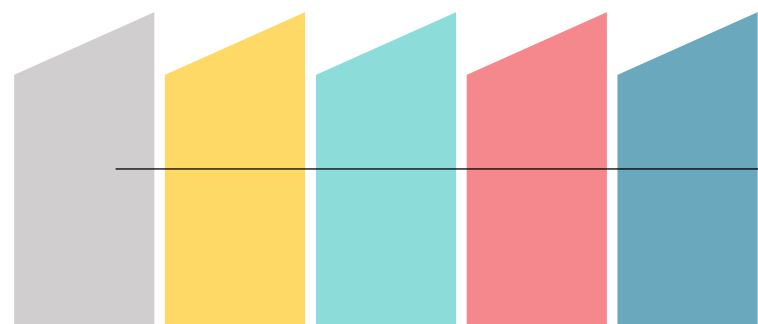

SAJAM PROIZVODNIH TEHNOLOGIJA

24-25. oktobar 2019 • Novosadski sajam

**OVO VAS
ČEKA NA
SAJMU!
I još mnogo
toga..**

organizatori:

SOLFINS

 **STROJOTEHNIKA**

PDM i PLM softverska rešenja

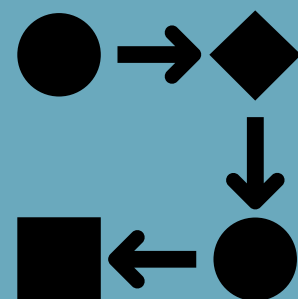

Kompletna rešenja za upravljanje procesima, projektima i poslovanjem, sa specijalizovanim rešenjima za vašu industriju i tipove proizvoda, za povezivanje sa vašim pozadinskim sistemima, sa platformom za efikasnu komunikaciju na projektima...

 **SOLIDWORKS**



 **ENOVIA**

3DEXPERIENCE®

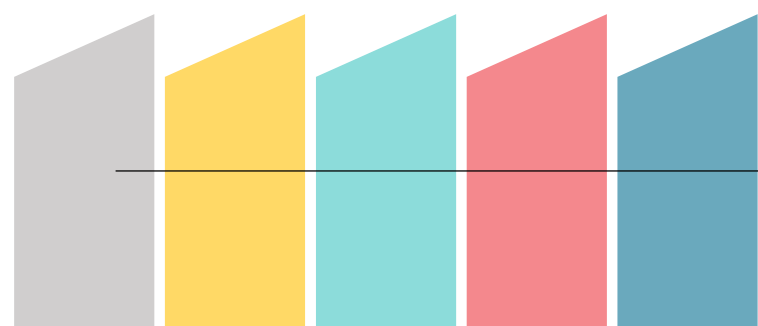

SAJAM PROIZVODNIH TEHNOLOGIJA

24-25. oktobar 2019 • Novosadski sajam

NOVO!
UPOZNAJTE
PONUDU
PARTNERA
SAJMA

organizatori:

SOLFINS

 **STROJOTEHNIKA**

FESTO **EPH FERRO**

meusburger[®] **KeyIT**

GARANT·WIS
generalni distributer za Srbiju 

BPP
GROUP 

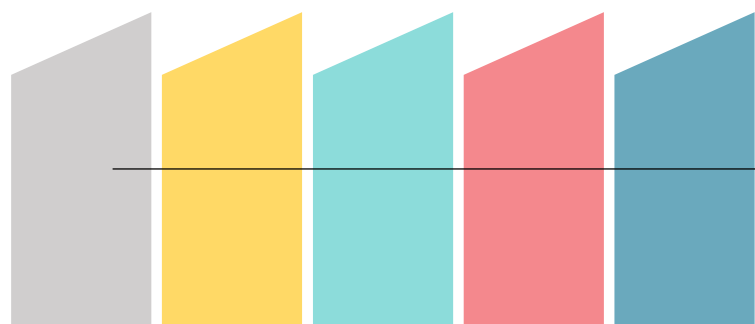

SAJAM PROIZVODNIH TEHNOLOGIJA

24-25. oktobar 2019 • Novosadski sajam

FESTO UPOZNAJTE PONUDU PARTNERA SAJMA

organizatori:

SOLFINS

 **STROJOTEHNIKA**

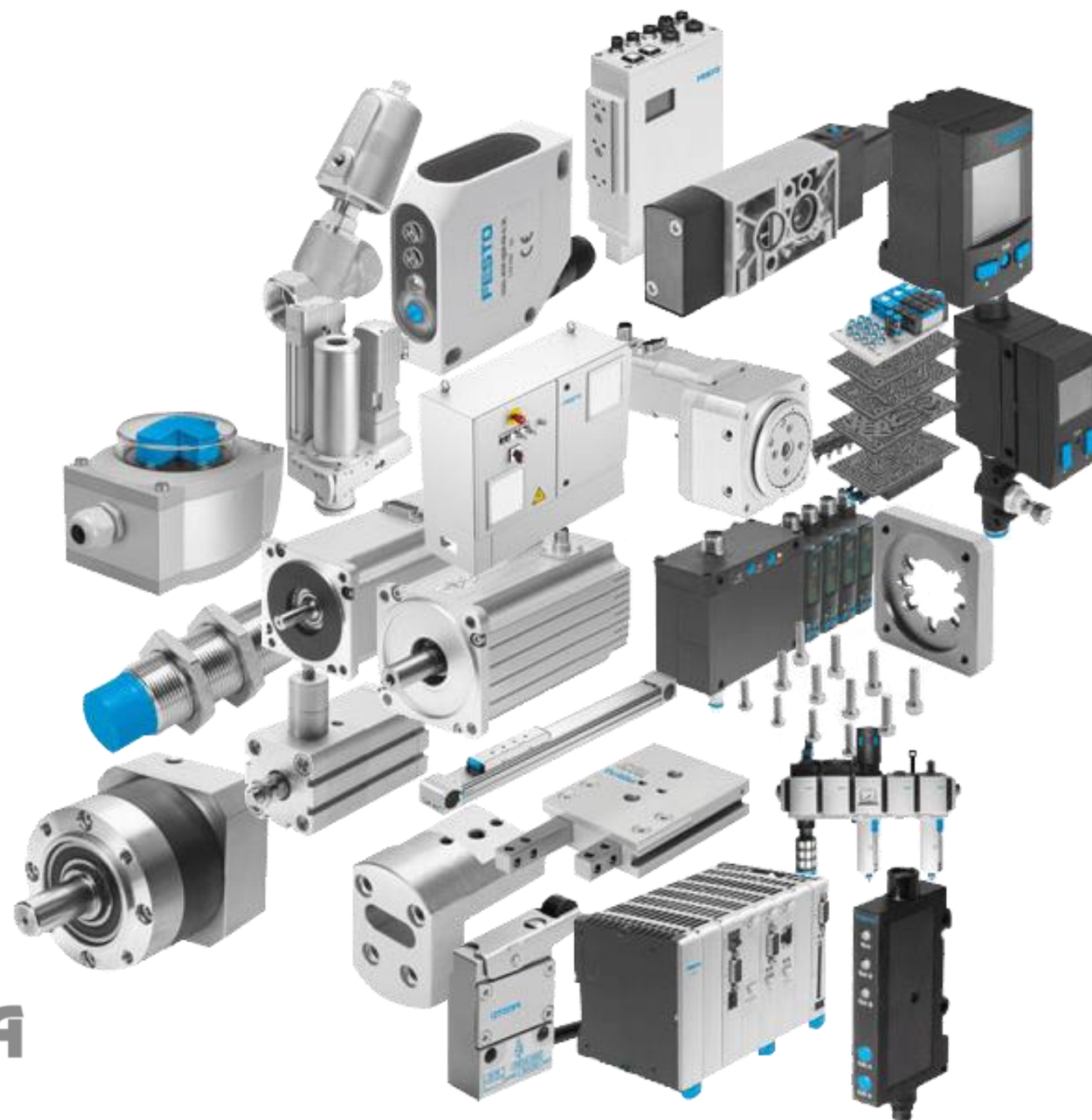

Pneumatski pogoni,
Servopneumatski sistemi
pozicioniranja, Elektromehanički
pogoni, Motori i kontroleri,
Hvataljke, Sistemi rukovanja,
Vakuumska tehnika, Ventili,
Ventilski blokovi, Motion Terminal,
Senzori, Sistemi za obradu slike,
Priprema vazduha pod pritiskom,
Sistem pneumatskih priključaka,
Električna tehnika spajanja,
Tehnika upravljanja i softver,
Softver, Druge pneumatske
komponente, Procesna
automatika, Sistemi "ključ u ruke",
Sistemi sa specifičnim
funkcijama...

FESTO

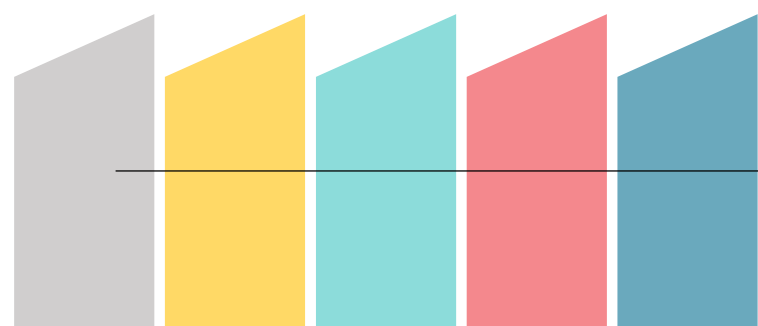

SAJAM PROIZVODNIH TEHNOLOGIJA

24-25. oktobar 2019 • Novosadski sajam

MEUSBURGER

UPOZNAJTE
PONUDU
PARTNERA
SAJMA



Standardni delovi alata za livenje
Alati za prosecanje i probijanje
Mašinogradnja
Radionička oprema
Specijalne ploče
Mašinska obrada

meusburger[®]

organizatori:

SOLFINS

 **STROJOTEHNIKA**

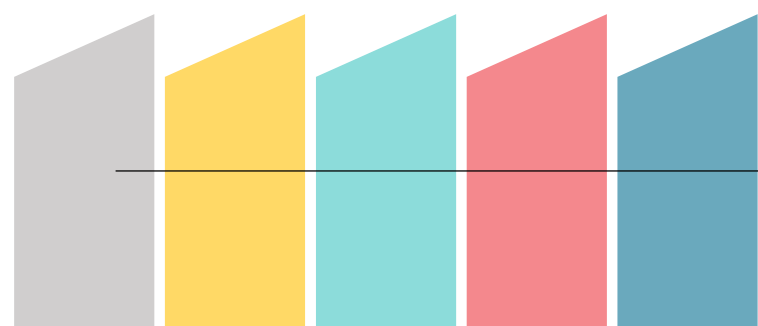

SAJAM PROIZVODNIH TEHNOLOGIJA

24-25. oktobar 2019 • Novosadski sajam

EPH FERRO

**UPOZNAJTE
PONUDU
PARTNERA
SAJMA**

organizatori:

SOLFINS

 **STROJOTEHNIKA**



Širok asortiman mašina,
od makaza, apkant
presa, panč presa,
mašina za kružno savijanje
lima i profila, mašina za
izradu ventilacionih
kanala, do laserskih CO2 i
fiber sistema za sečenje
lima.

EPH FERRO

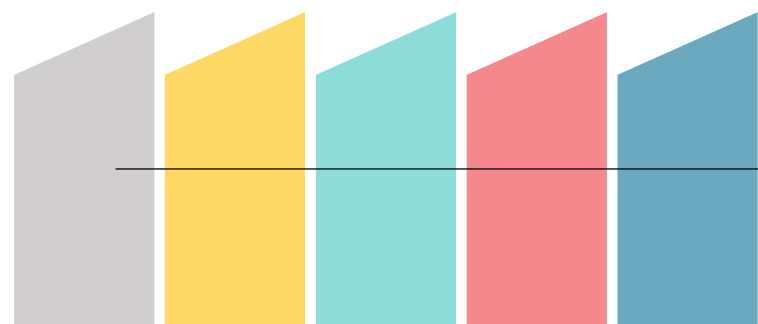

SAJAM PROIZVODNIH TEHNOLOGIJA

24-25. oktobar 2019 • Novosadski sajam

KEYIT UPOZNAJTE PONUDU PARTNERA SAJMA

organizatori:

SOLFINS

 **STROJOTEHNIKA**



Prodaja i implementacija softverskih rešenja, kao i pružanje konsultantskih usluga pri izboru rešenja: UPIS.Net, UPIS.Partner, Mali UPIS, UPIS.Kasa, UPIS.MOB, UPIS.API, UPIS.WEB, UPIS.MDS...

KeyIT

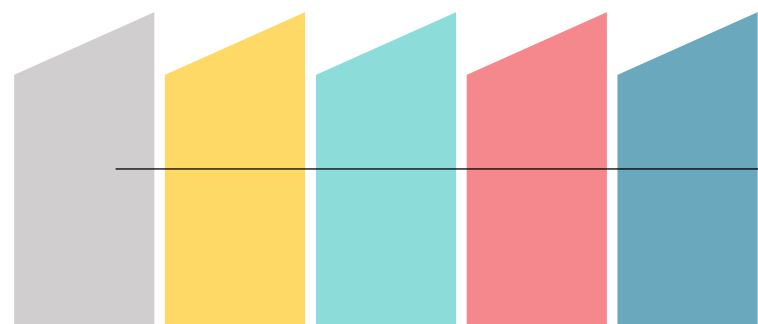

SAJAM PROIZVODNIH TEHNOLOGIJA

24-25. oktobar 2019 • Novosadski sajam

BPP GROUP

UPOZNAJTE
PONUDU
PARTNERA
SAJMA

organizatori:

SOLFINS

 **STROJOTEHNIKA**



BPP Group je ovlašćeni
distributer Kaeser
Kompressoren za Srbiju.

Kaeser Kompressoren nudi
proizvode, usluge i
kompletna rešenja za
proizvodnju, obradu i
isporuku energije u obliku
komprimovanog vazduha.

BPP
GROUP

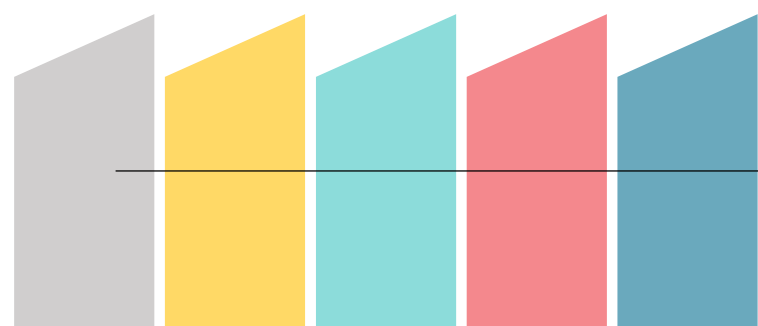

SAJAM PROIZVODNIH TEHNOLOGIJA

24-25. oktobar 2019 • Novosadski sajam

GARANT WIS

**UPOZNAJTE
PONUDU
PARTNERA
SAJMA**

organizatori:

SOLFINS

 **STROJOTEHNIKA**

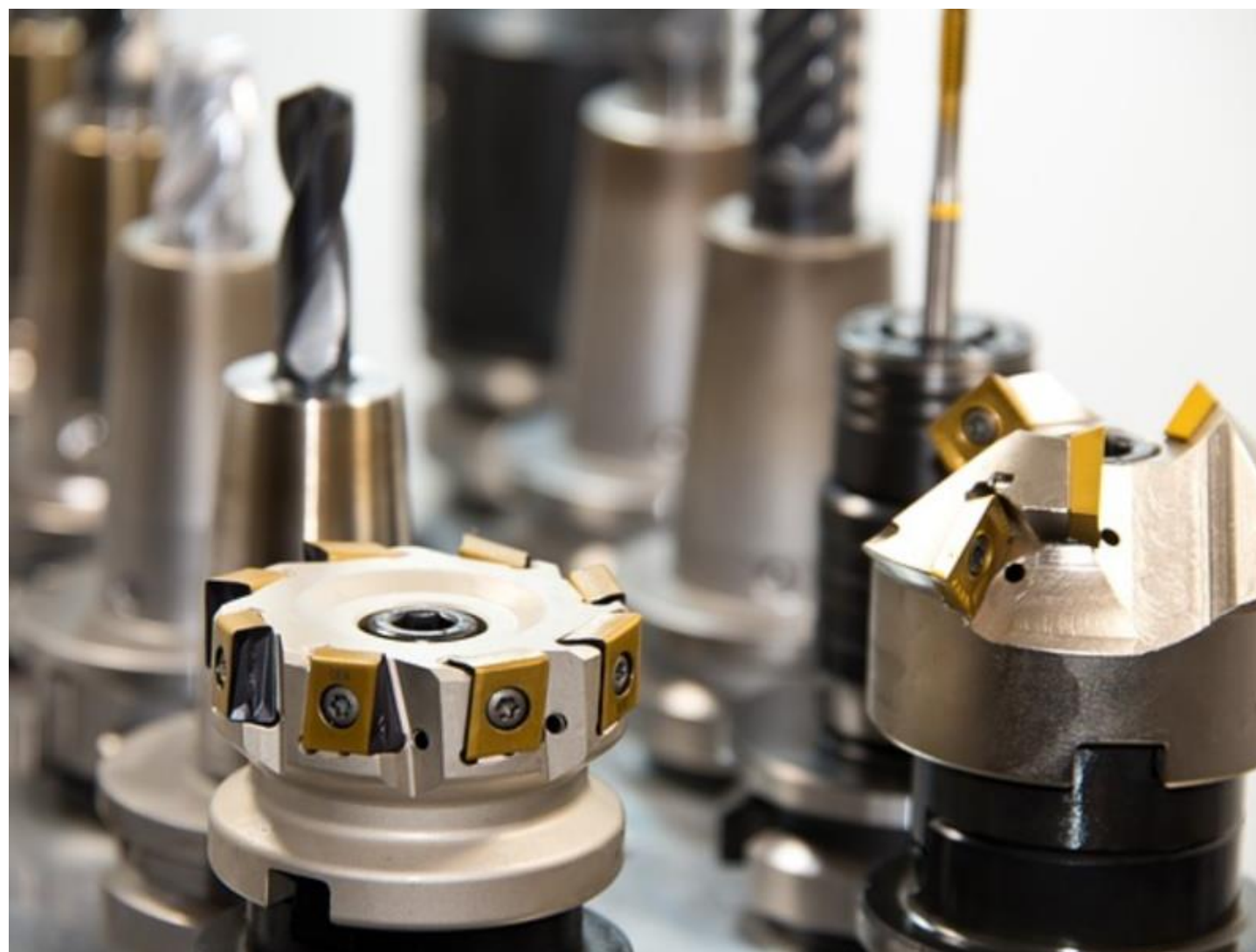

Prodaja i usluga servisa
reznog alata, izrada
specijalnog alata

- Walter-Tools generalni zastupnik
- Urma Wiess generalni zastupnik
- Oštrenje reznog alata

 **GARANT-WIS**
generalni distributer za Srbiju 

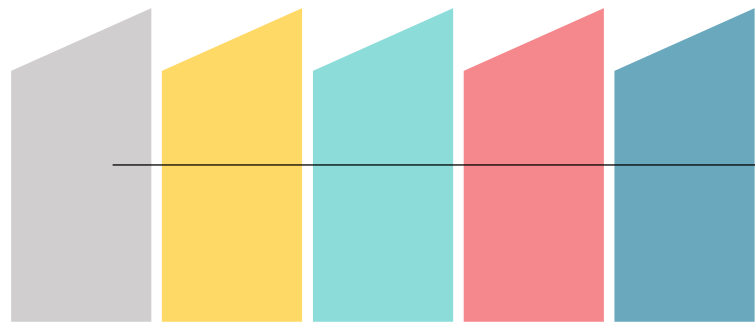

SAJAM PROIZVODNIH TEHNOLOGIJA

24-25. oktobar 2019 • Novosadski sajam

**NAGRADNI
TURNIRI
za CAD i CAM
mađioničare**

organizatori:

SOLFINS

 **STROJOTEHNIKA**

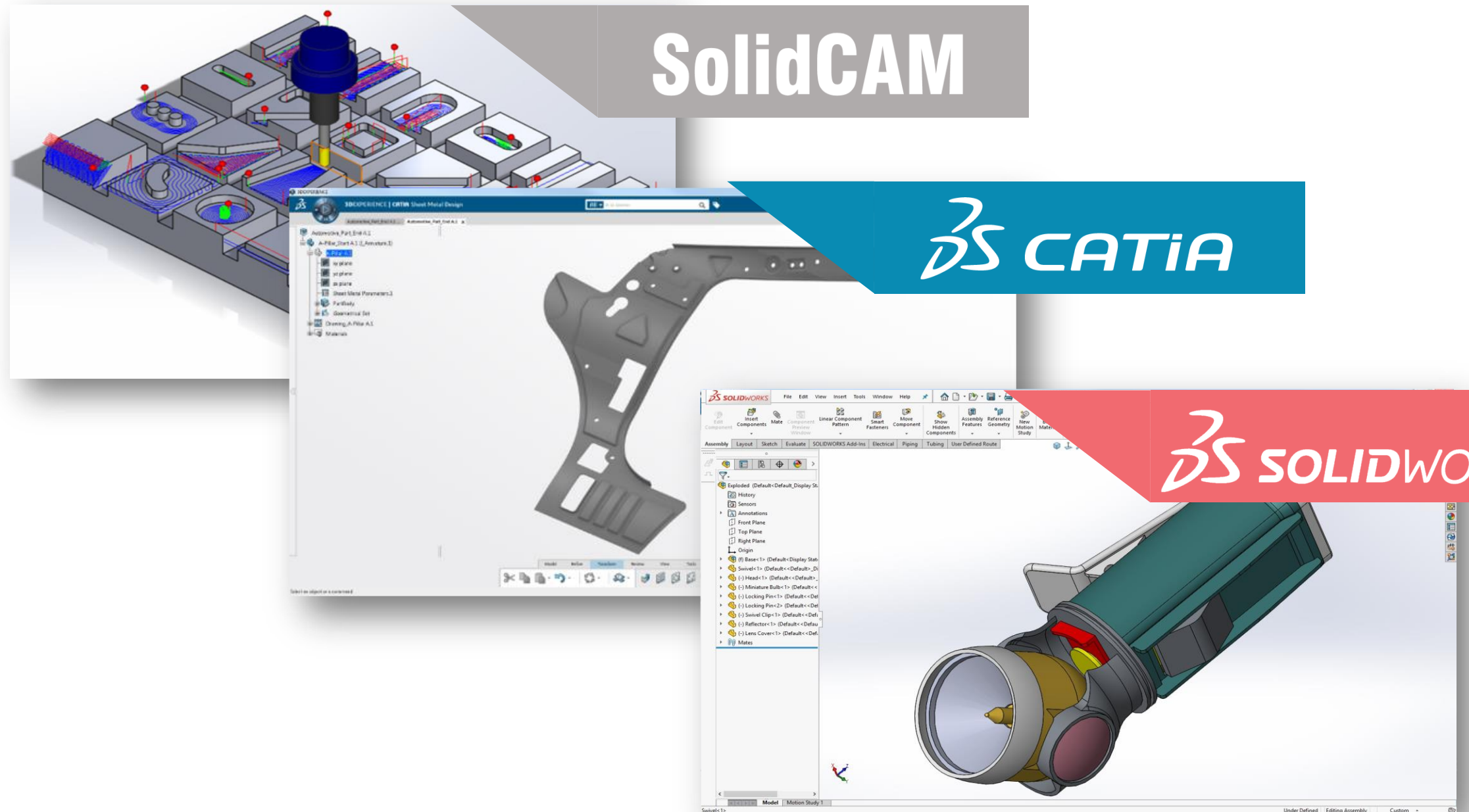

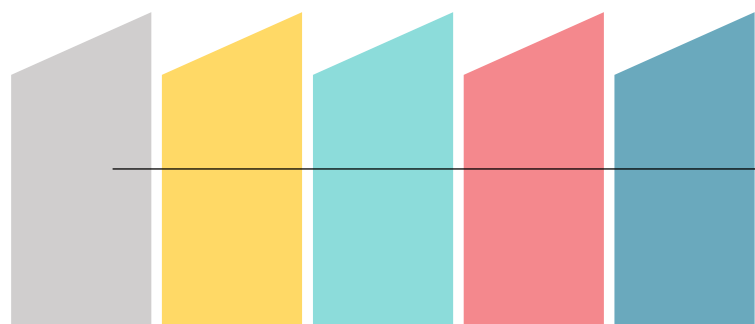

SAJAM PROIZVODNIH TEHNOLOGIJA

24-25. oktobar 2019 • Novosadski sajam

**CAD i CAM
TURNIRI
takmičenja u
modelovanju i
programiranju**



slike: Sajam proizvodnih tehnologija 2018

organizatori:

SOLFINS

 **STROJOTEHNIKA**



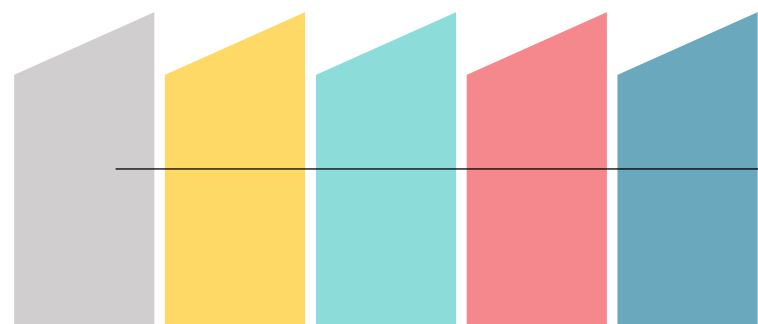

SAJAM PROIZVODNIH TEHNOLOGIJA

24-25. oktobar 2019 • Novosadski sajam

ZABAVA
žurka i sportovi
na kraju
radnog dana
sajma



slike: Sajam proizvodnih tehnologija 2018

organizatori:

SOLFINS

 **STROJOTEHNIKA**



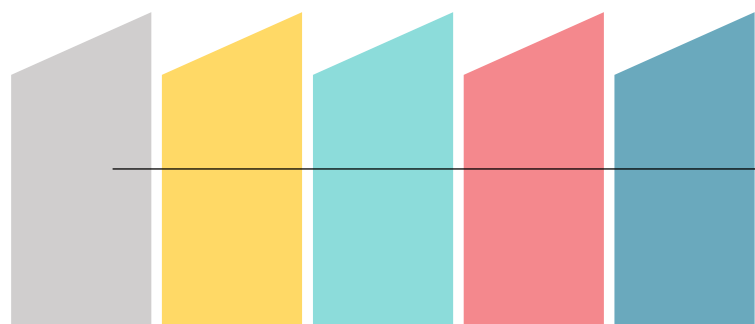

SAJAM PROIZVODNIH TEHNOLOGIJA

24-25. oktobar 2019 • Novosadski sajam

LOKACIJA HALA MASTER

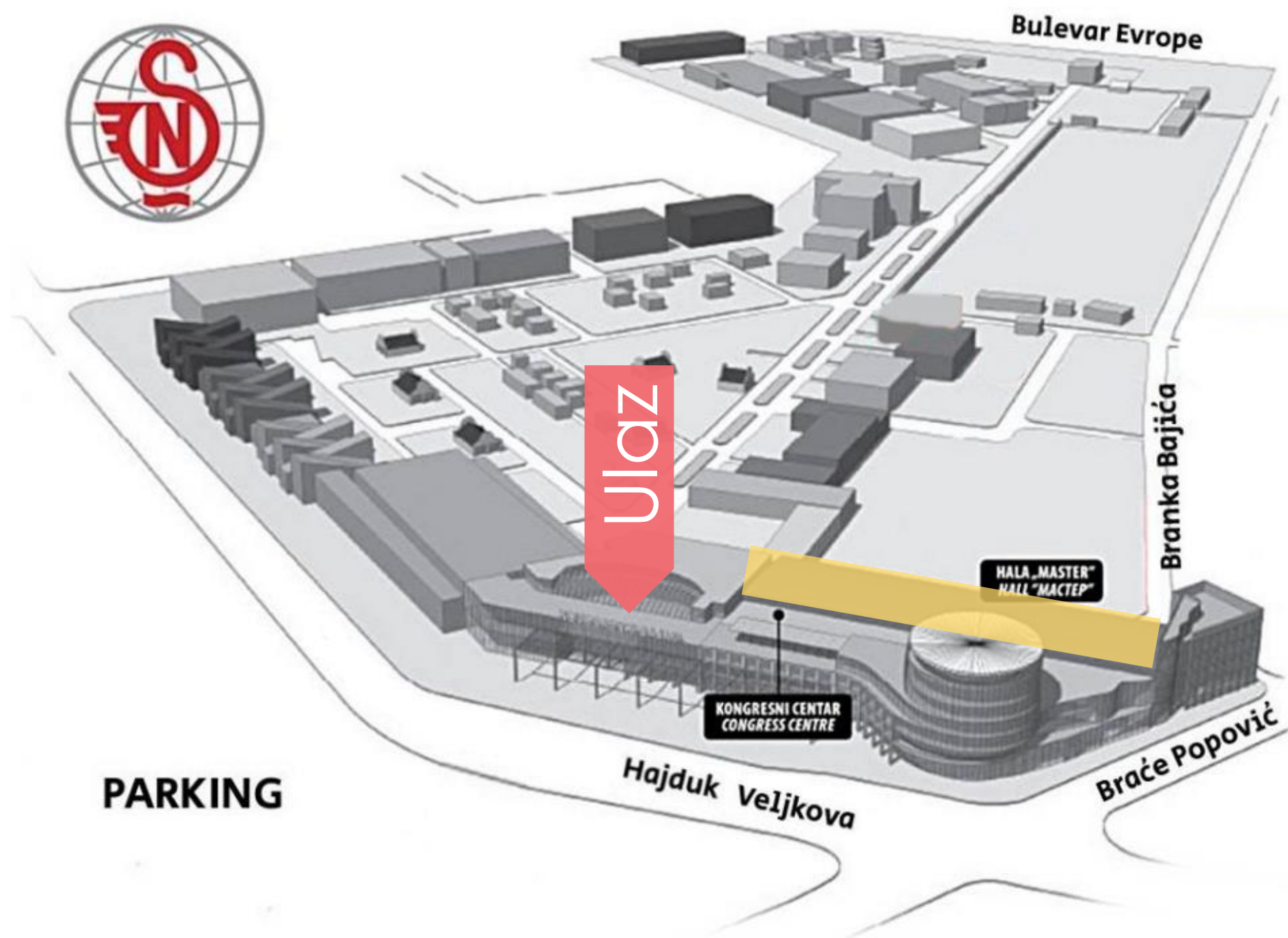

organizatori:

SOLFINS

 **STROJOTEHNIKA**

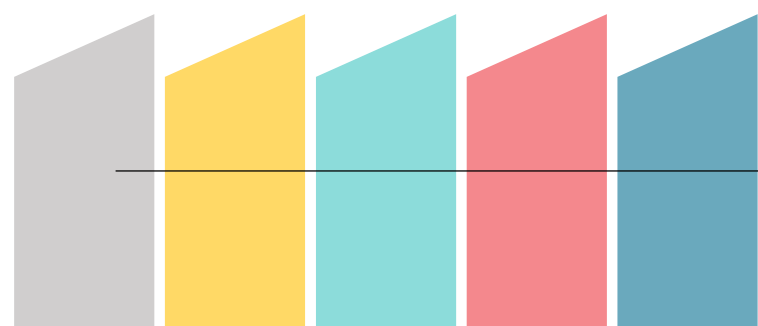

SAJAM PROIZVODNIH TEHNOLOGIJA

24-25. oktobar 2019 • Novosadski sajam

**SPECIJALNA
HOTELSKA
PONUDA
POPUSTI ZA
UČESNIKE
SAJMA**

organizatori:

SOLFINS

 **STROJOTEHNIKA**



Garni
Hotel Planeta Inn



Itica
GARNI HOTEL • DM



**HOTEL
VELIKI**
GARNI HOTEL ★★★



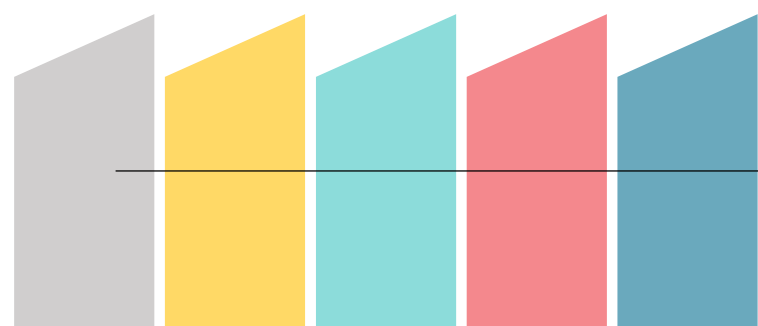

SAJAM PROIZVODNIH TEHNOLOGIJA

24-25. oktobar 2019 • Novosadski sajam

**REZRVIŠI
ULAZNICE
OBAVEZNA
REGISTRACIJA
POSETILACA**

**Više informacija i
rezervacija **besplatnih**
ulaznica
na Solfins sajtu:**

organizatori:

SOLFINS

 **STROJOTEHNIKA**

solfins.com